

[2022 GMC Sierra 1500 - 4WD New \(RPO J22, VIN Digit 5 = U\) \(3GTPUCEK1NG601032\)](#) |  
[Sierra 1500 New Accessory Installation Manual](#) | [Accessories](#) | [Interior Accessories](#) | [Accessories](#) |

**Document ID: 5862954**

## Front Side Door Sill Trim Plate Package Installation (Instruction ID: 85527849)

### Installation Instructions Part Number

85527849

**Note: Procedure might have changed since the last time.**

### Kit Contents

Qty	Description
2	Illuminated Sill Plate Assembly
1	Wiring Harness Pkg (Contains Harness ASM (QTY 1) and Wire Tie Straps (QTY 8))

### Recommended Tools

- Drill, 19 mm, (3/4") drill bit
- 1¼" Hole Saw
- Flat Bladed Plastic Trim Tool
- 2mm Width Flat Screwdriver
- 0.8mm Width Flat Screwdriver
- Push-in Retainer Puller
- Electrical Tape
- 10mm Socket
- Trim Removal Tools
- Small Ratchet
- Wire Puller
- Heat Gun
- Wire Crimp Tool
- Magnet and / or Vacuum

### Procedure



1. Move the front seats to the furthest rearward position.



© 2022 General Motors. All rights reserved.

2. Pull upward and remove the front seat adjuster track finish cover (1).



3. Starting at the rear of the garnish molding, pull upward at the B-pillar joint to release the up/down clips first.
4. Rotate the sill garnish molding (1) inboard after releasing up/down clips and pull rearward to disengage the two clips on the forward vertical wall.



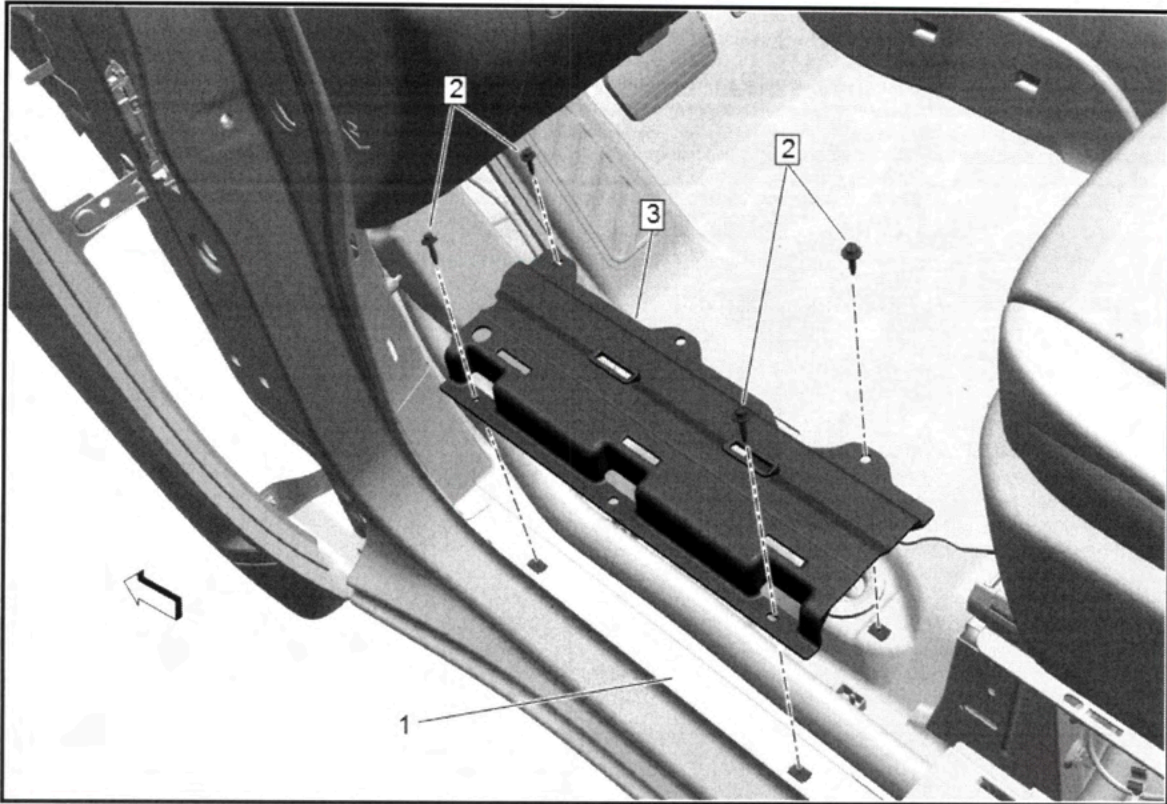

5. Remove the screws (2) from the harness sill protector (3).
6. Remove the harness sill protector (3) from rocker panel (1).

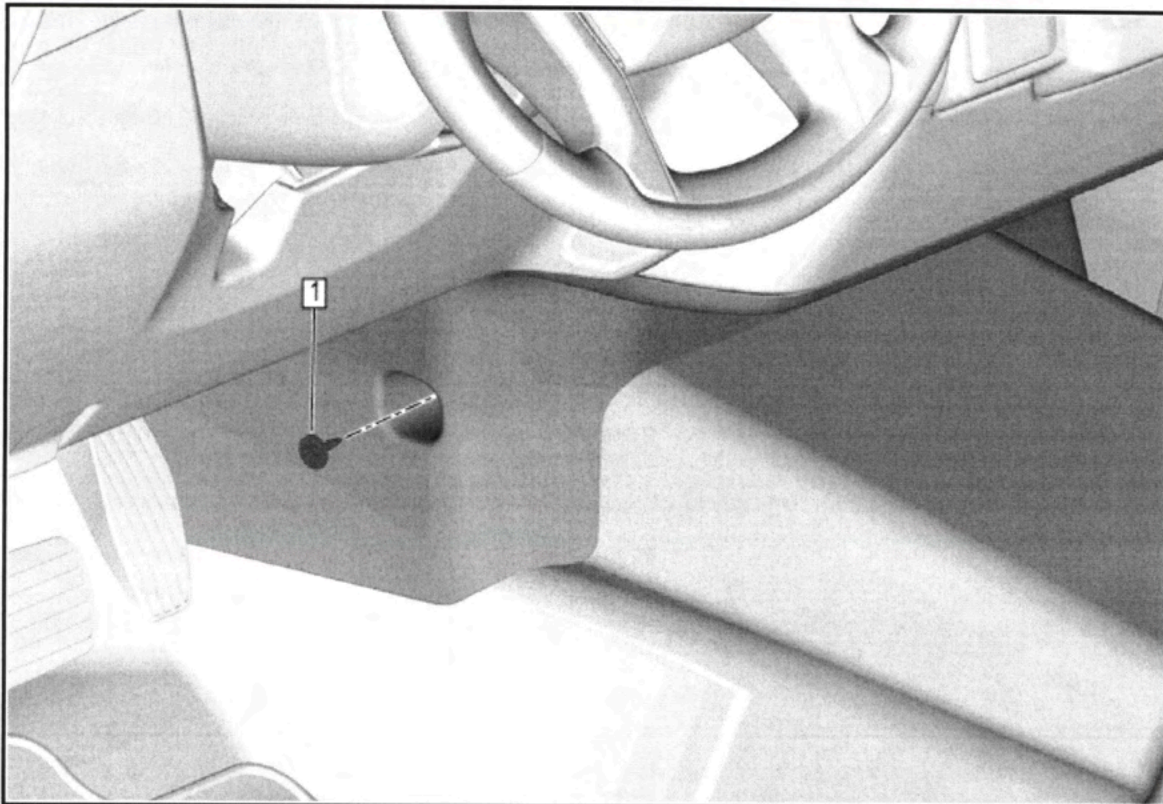

**Note:** If vehicle is equipped without center console continue with step 7. If vehicle is equipped with center console proceed to step 8.

- 7. Vehicles Without Center Console:** Remove the bolt (1) from each side of the instrument panel lower center trim panel. Upon reassembly tighten the bolt to 2.5 N.m (22 lb in).



7.1. Remove the instrument panel lower center trim panel (1) from lower instrument panel.

**8. Vehicles With Center Console:**

Move the front seat to access the retainers.

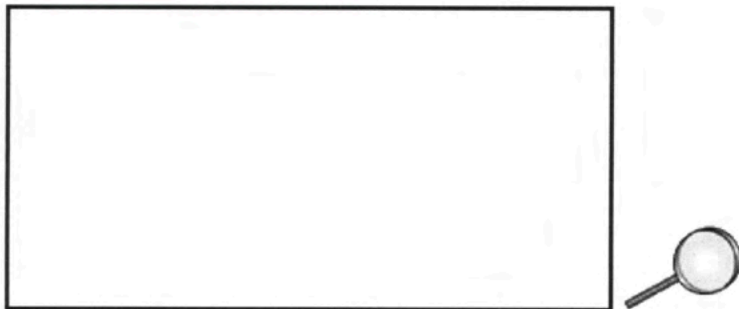

8.1. **Left Front Floor Console Extension Panel:** Front Floor Console Extension Panel Bolt Access Hole Cover (1) » Remove

8.2. Front Floor Console Extension Bolt (2) » Remove Upon reassembly tighten the bolt to 2.5 N.m (22 lb in).



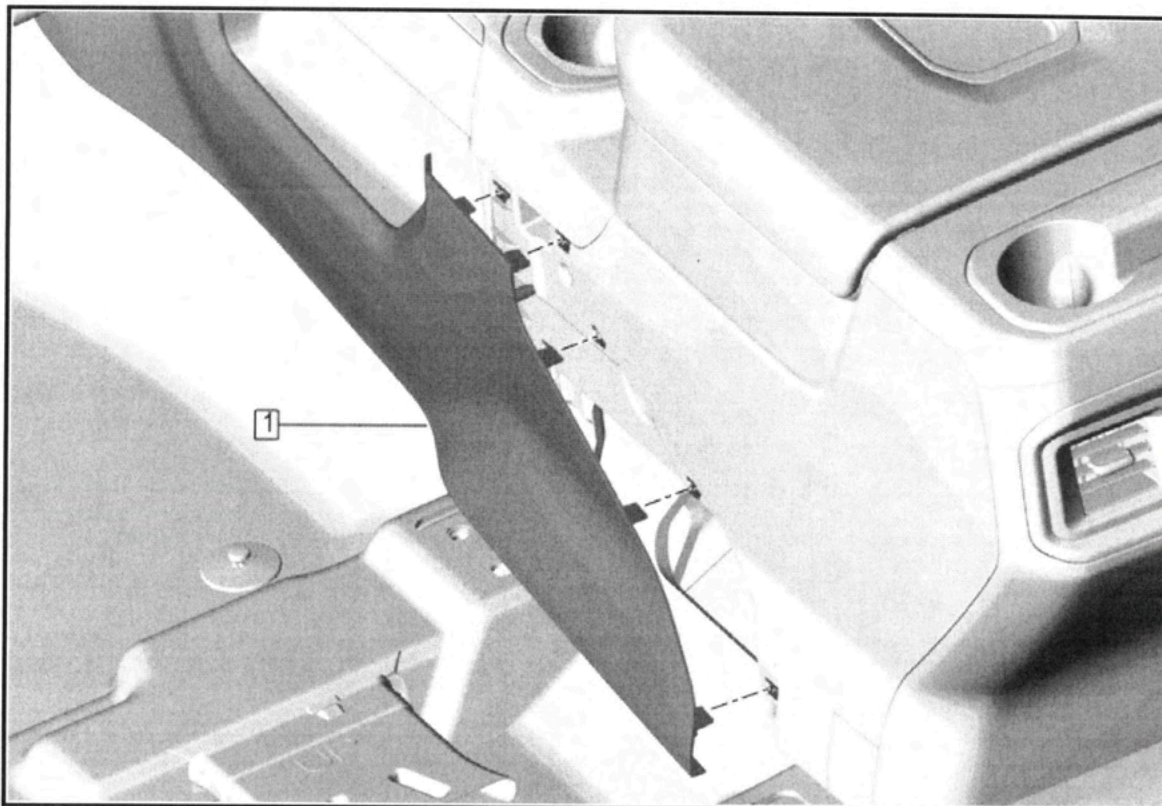

8.3. Starting from the rear, use a flat bladed plastic trim tool to aid in the removal of the panel (1) from the front floor console.

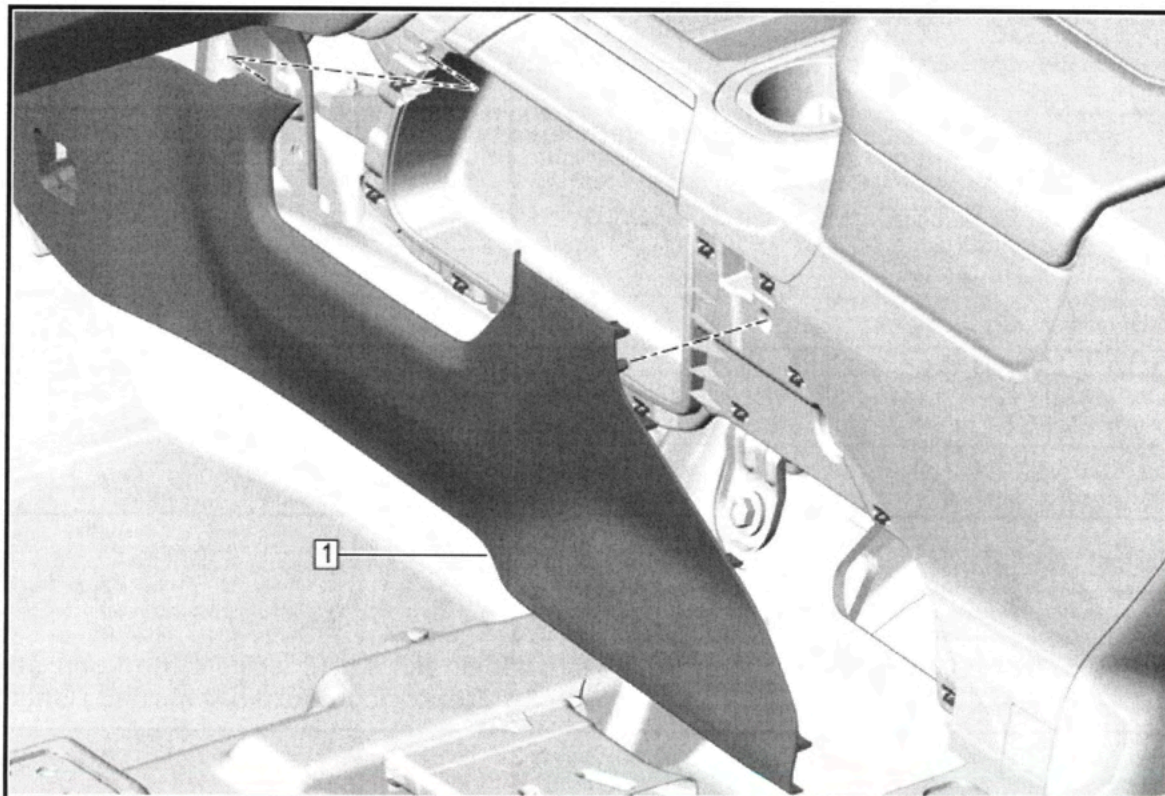

© 2022 General Motors. All rights reserved.

#### 8.4. Front Floor Console Extension Panel - Left Side (1) » Remove

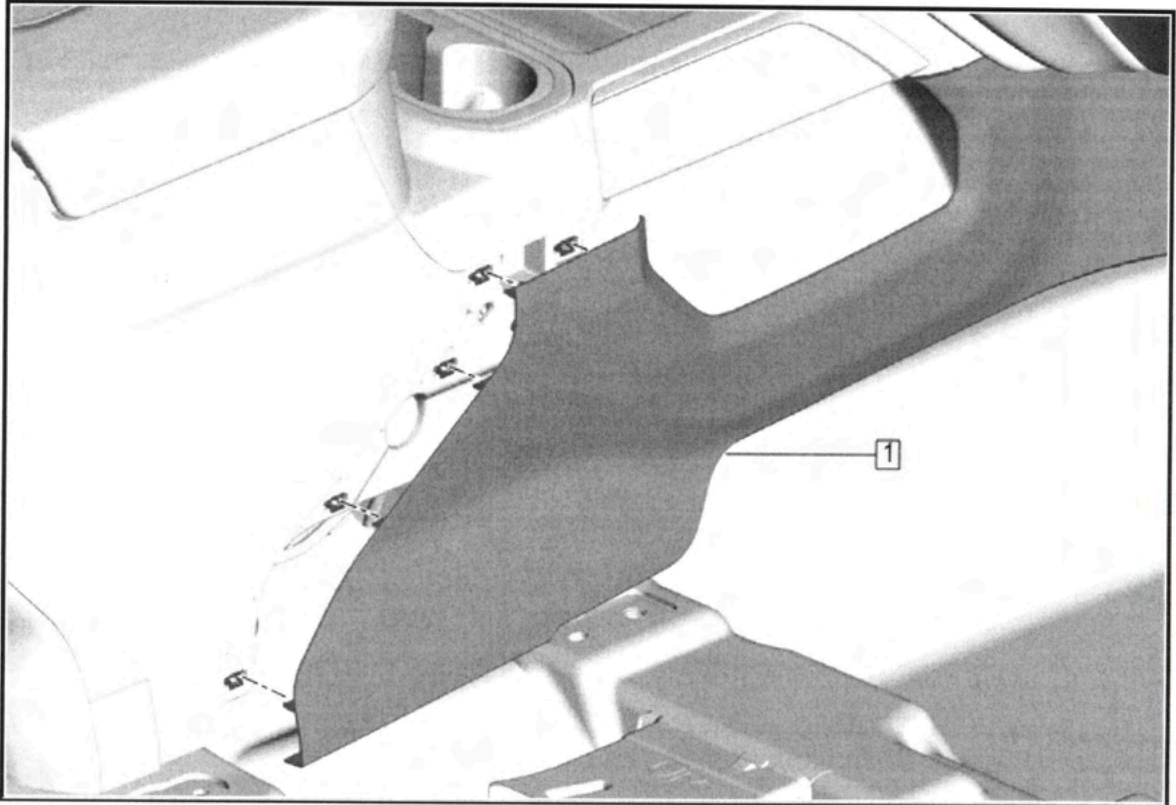

- 8.5. **Right Front Floor Console Extension Panel:** Starting from the rear, use a flat bladed plastic trim tool to aid in the removal of the front floor console extension panel (1) from the front floor console.



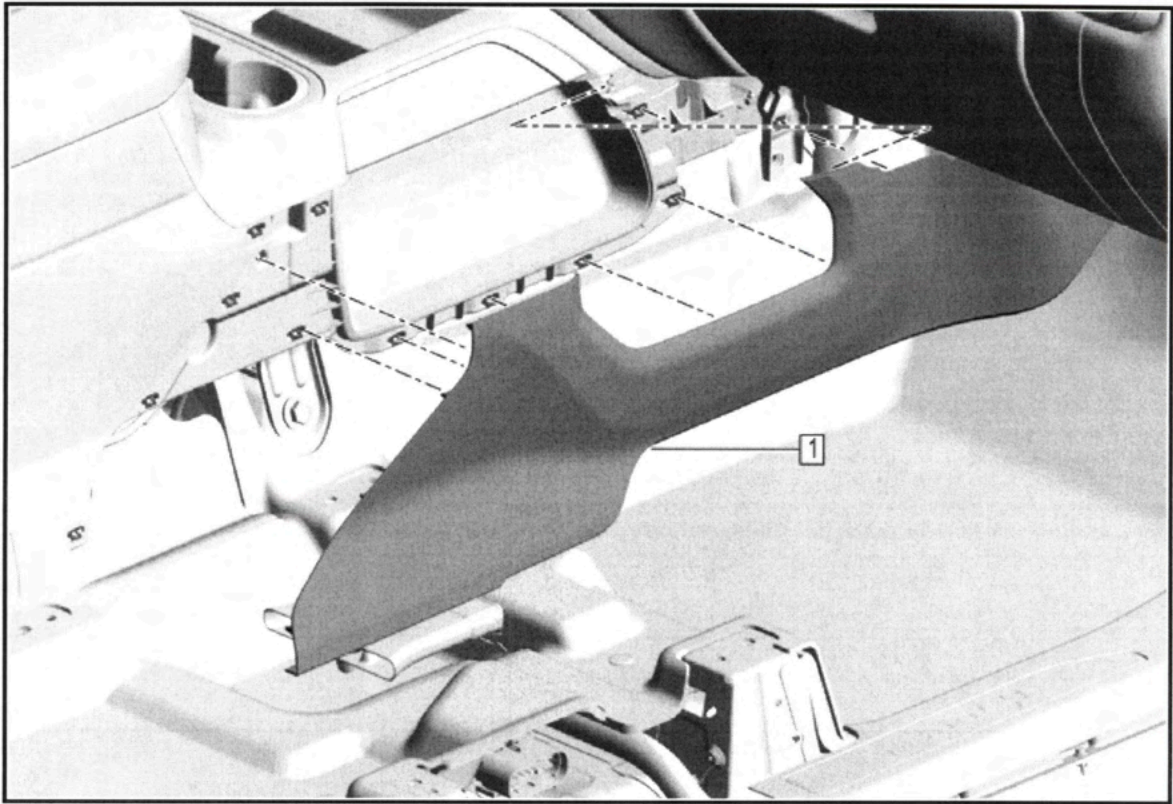

8.6. Front Floor Console Extension Panel - Right Side (1) » Remove

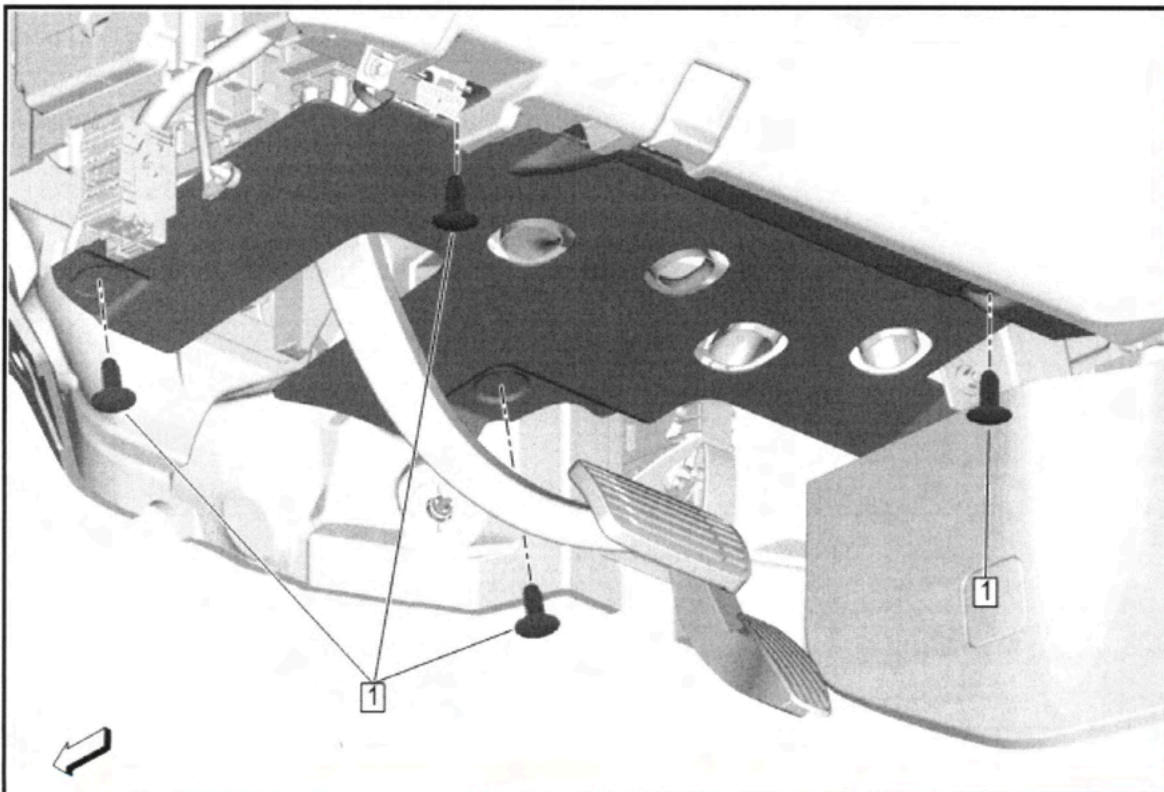

9. Remove the retainers (1) from the instrument panel lower insulator, if equipped.

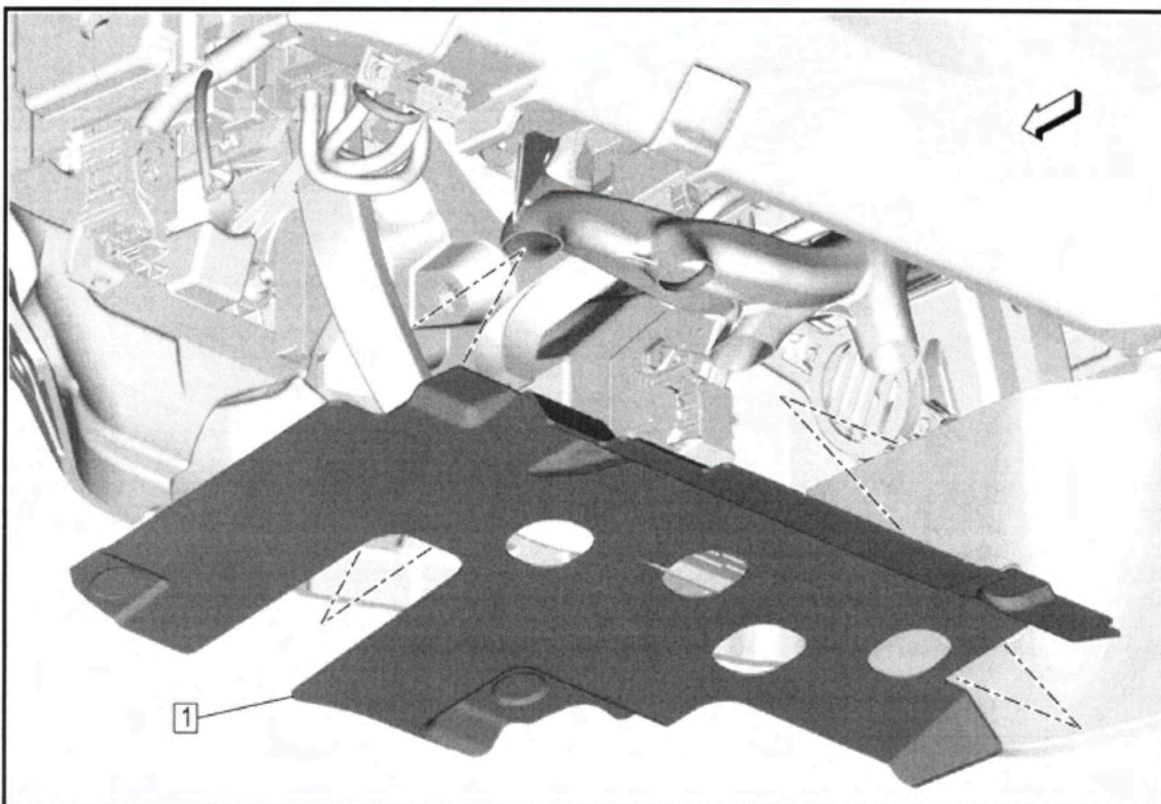

10. Remove the instrument panel lower insulator (1) from lower instrument panel, if equipped.
11. Remove front floor mats and reposition front carpet as necessary.

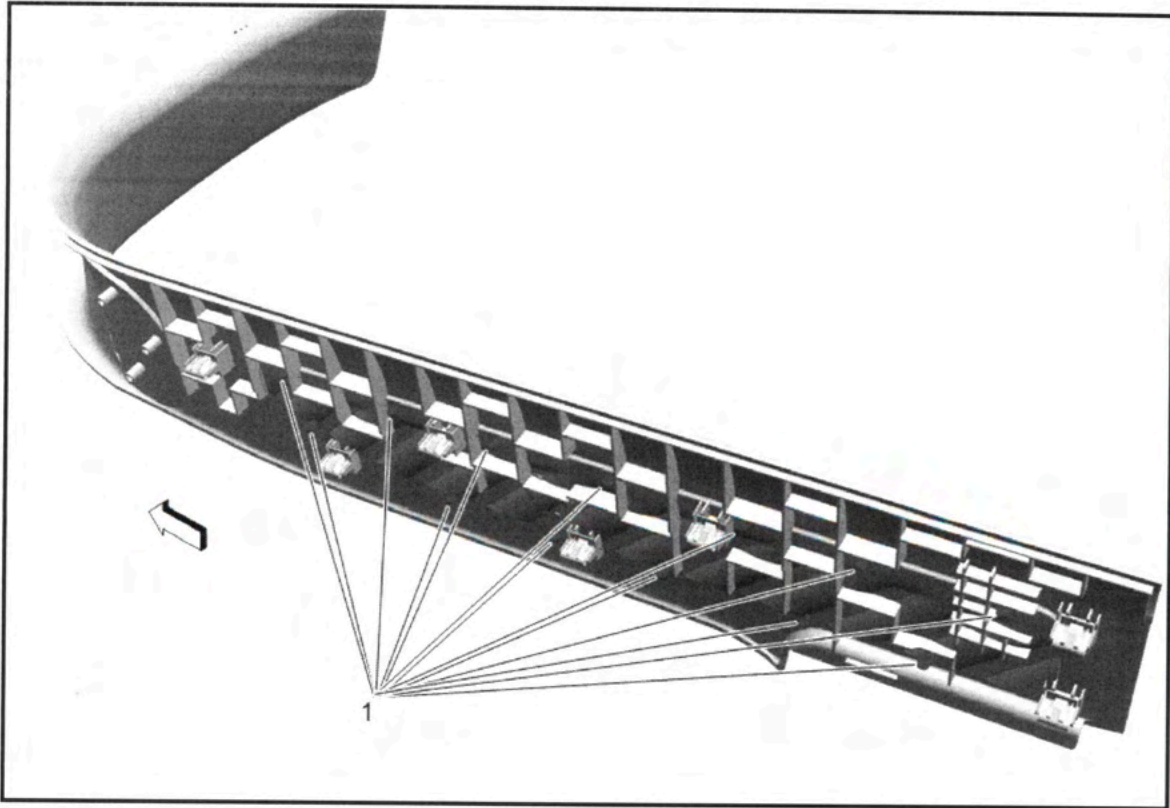

12. Disengage the sill center tabs (1) on the back side of the sill garnish molding.

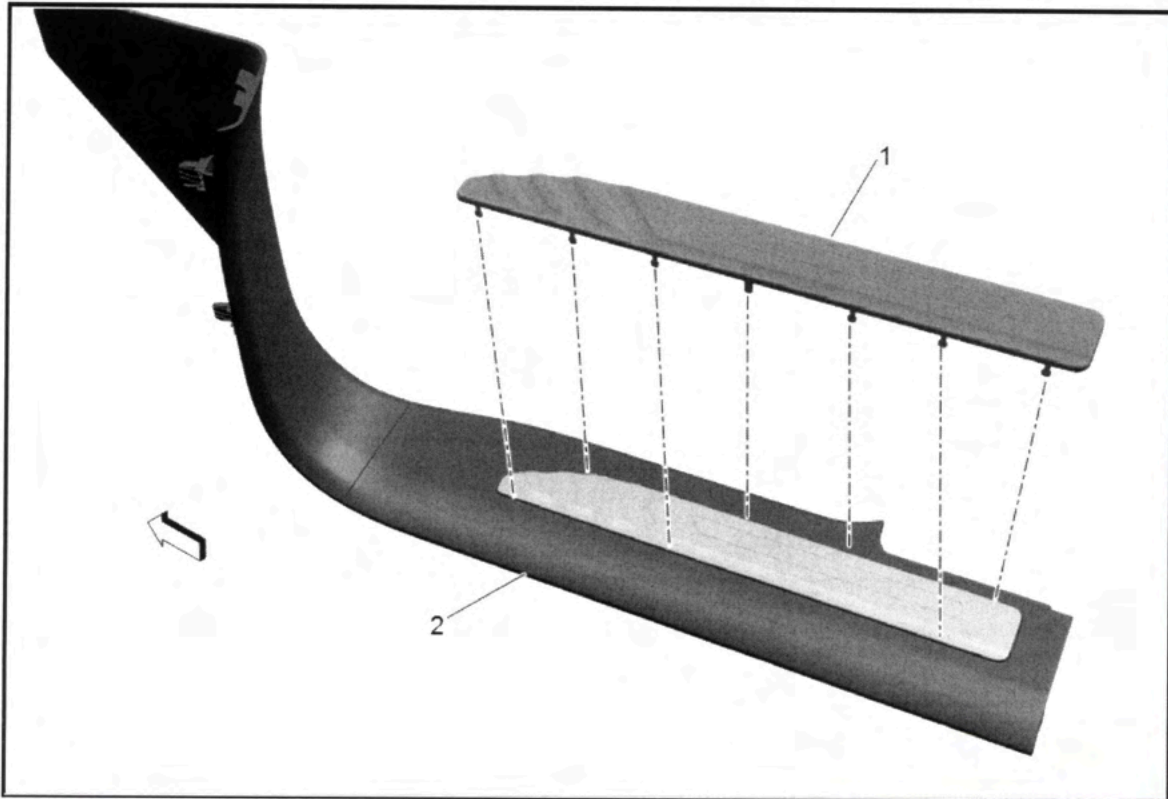

© 2022 General Motors. All rights reserved.



13. Remove the sill center (1) from the sill garnish molding (2).

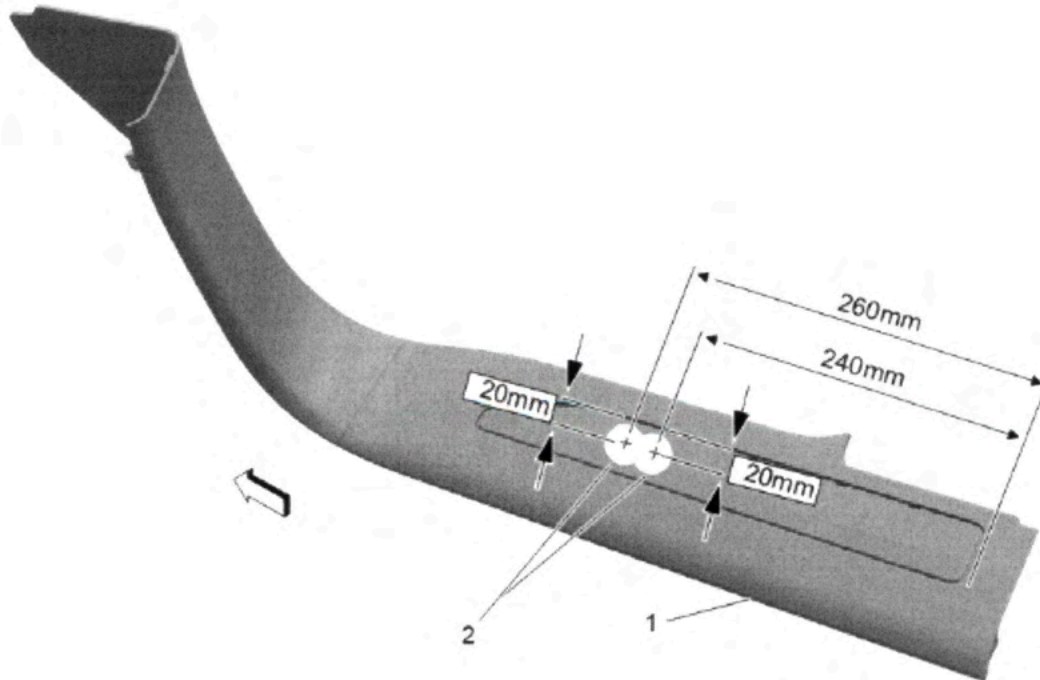

**Note:** Always check scale, size and position of all holes before drilling. Failing to do so may cause damage to the vehicle, misalignment of components or the inability to install the accessory.

**Note:** it is recommended to drill pilot holes to ensure accurate locations.

14. Drill two 32mm (1.25") diameter holes (2) into the sill garnish molding (1) according to the dimensions shown.

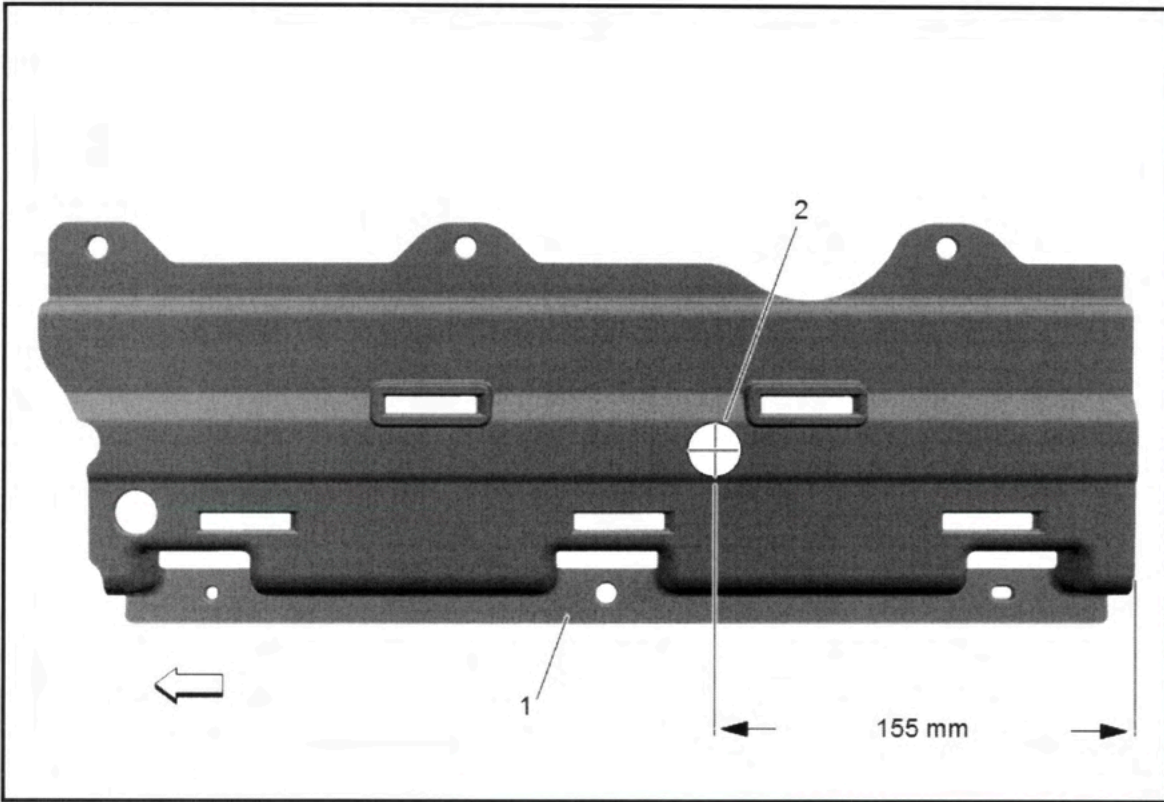

15. Drill a 19 mm (3/4") hole (2) into the harness sill protector (1) according to the dimensions shown.

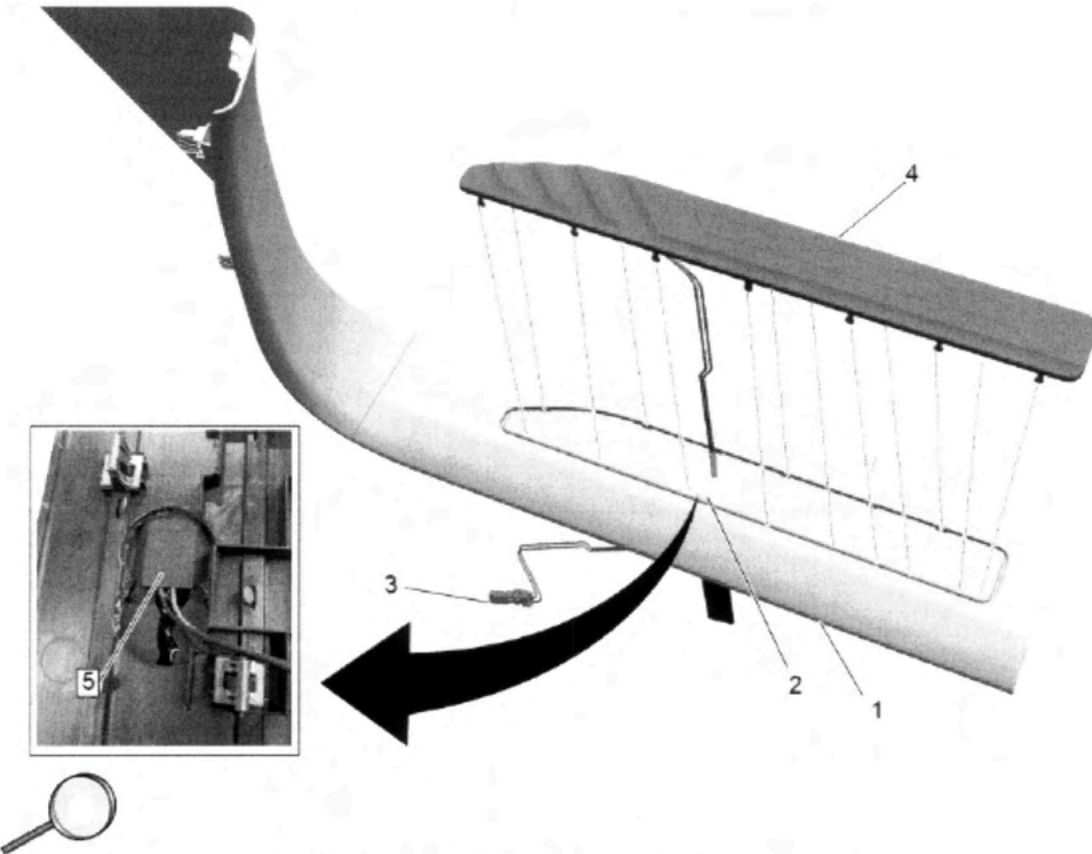

© 2022 General Motors. All rights reserved.

**Note:** It is important for the circuit board (5) to fit in the holes (2).

16. Insert the electrical connector (3) of the illuminated sill (4) through the previously drilled holes (2) in the sill garnish molding (1).
17. Pull harness through and install the illuminated sill (4) to the sill garnish molding (1) engaging the center tabs on the under side of sill garnish molding.



18. Route wiring harness through the vehicle as shown.

18.1. Begin by spreading out the harness to understand how it is routed through the vehicle. The harness will route from the driver side, to the passenger side, near the top edge of the carpet. The ground eyelet attaches in the passenger side cowl and the two loose wires attach to the BCM harness under the driver side of I/P.

18.2. 2. Route the harness (1) loosely across the dash panel near the top of the carpet with the BCM connections on driver side under I/P, and ground (2) on the right side.



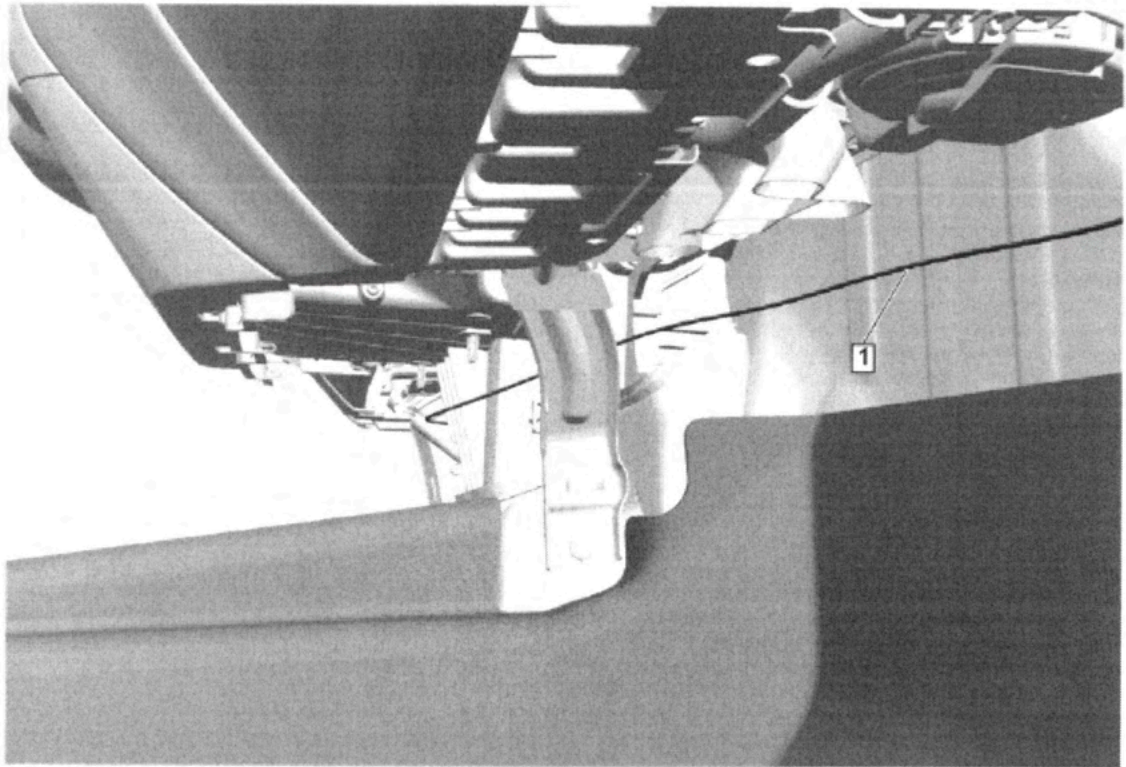

18.3. View from the right side of lower instrument panel showing the routing of the harness (1).

18.4. Use supplied tie straps to secure harness to existing harness. Be sure to secure harness away from the accelerator pedal.

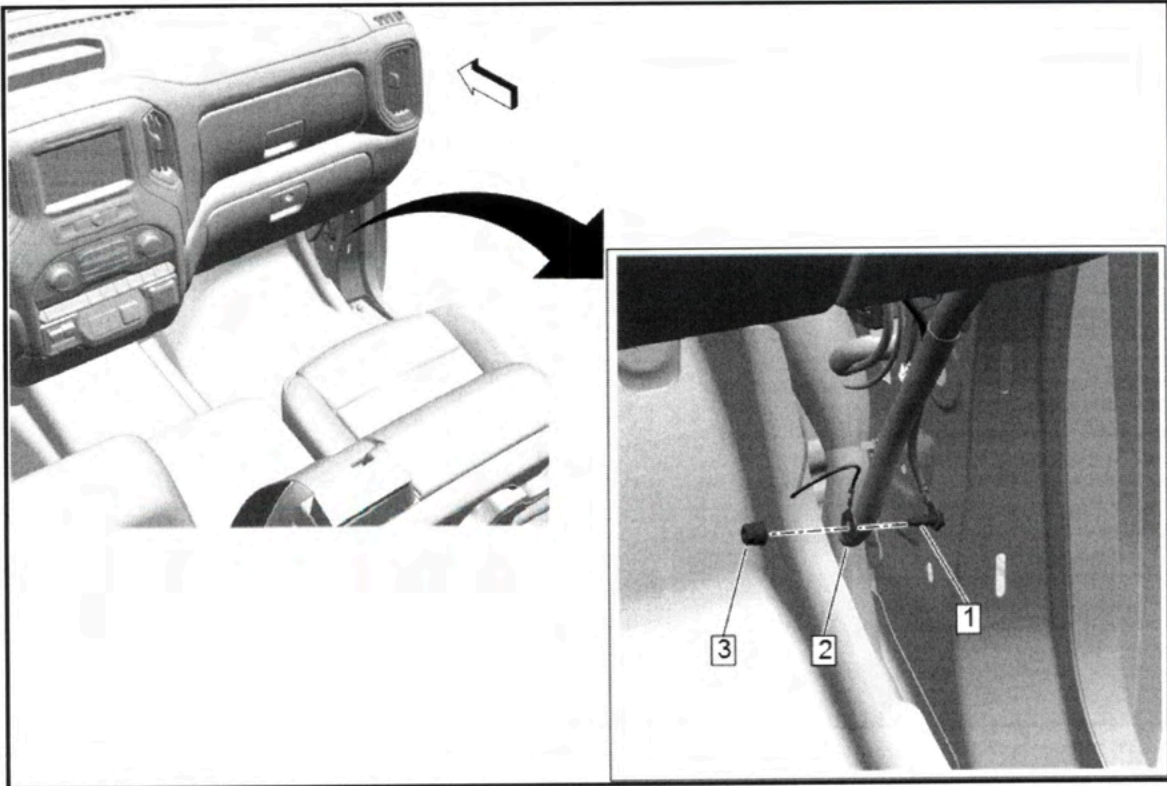

19. Locate the ground stud (1) on the passenger side cowl. If equipped with more than one stud, choose the stud with only one eyelet.
20. Remove the ground nut (3) and install the illuminated sill plate harness ground eyelet (2) to the ground stud (1).

**Caution:** Use the correct fastener in the correct location. Replacement fasteners must be the correct part number for that application. Fasteners requiring replacement or fasteners requiring the use of thread locking compound or sealant are identified in the service procedure. Do not use paints, lubricants, or corrosion inhibitors on fasteners or fastener joint surfaces unless specified. These coatings affect fastener torque and joint clamping force and may damage the fastener. Use the correct tightening sequence and specifications when installing fasteners in order to avoid damage to parts and systems.

21. Reinstall the ground nut (3) and tighten to 25 N.m (18 lb in).

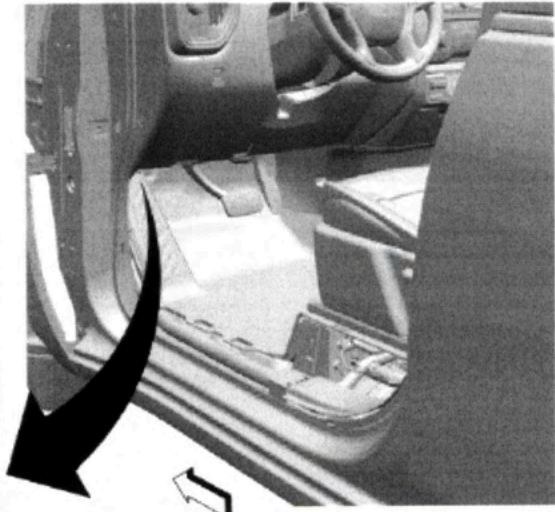
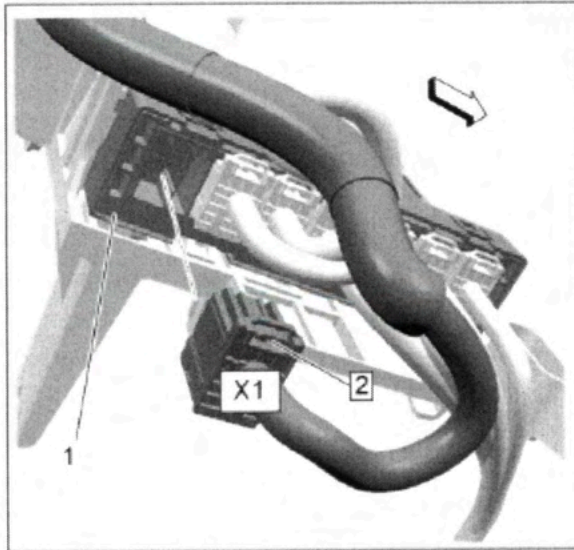

22. Locate the BCM (1) on the driver side of the vehicle, under the I/P. Locate BCM connector X1 and open the CPA (2) (connector position assurance). Disconnect BCM connector X1 from the BCM (1).

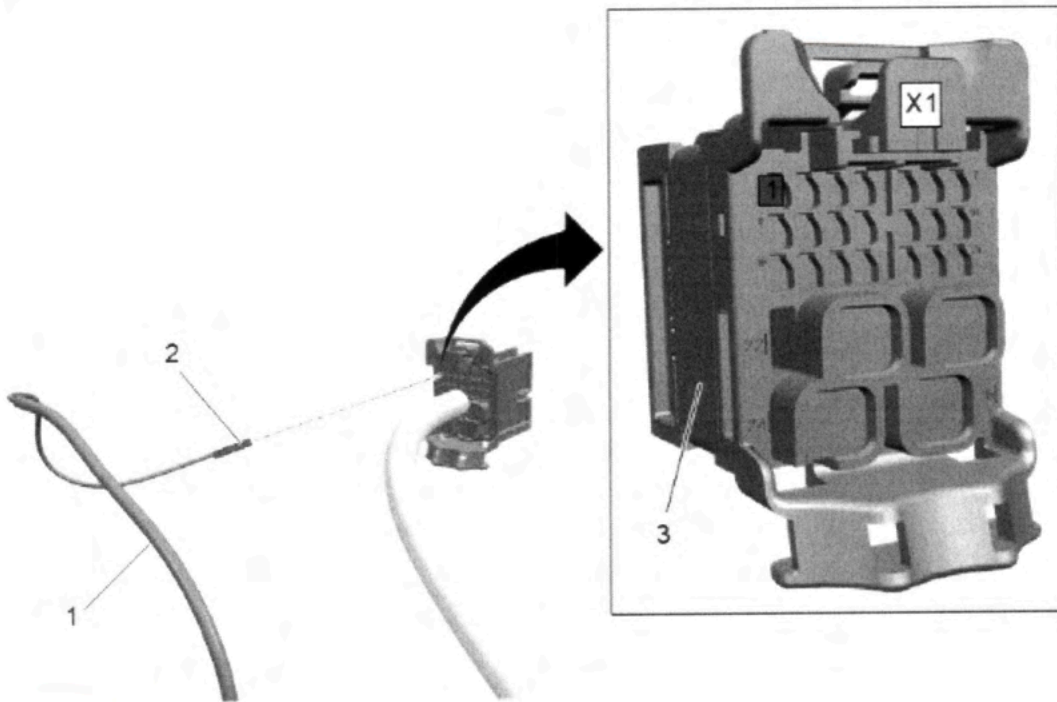

© 2022 General Motors. All rights reserved.



**Important:** DO NOT remove the terminal from connector.

23. Disengage the ISL (3) (Isolated Secondary Lock) on BCM connector X1 and locate cavity #1 on the removed connector.
24. On the supplied wire harness (1) locate the loose circuit (2), insert circuit 157 (Gray) into cavity 1. Gently push to seat the terminal.
25. Re-engage the ISL (3) (Isolated Secondary Lock) on BCM connector X1. Tape the wire to the existing bundle.

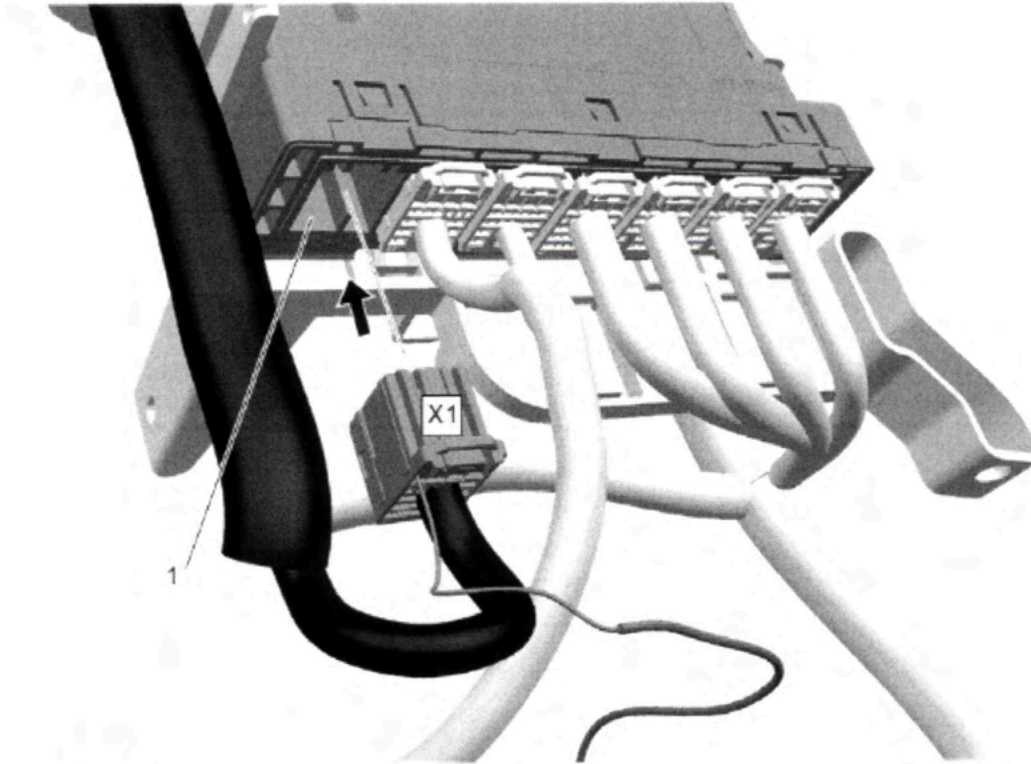

26. Re-connect connector X1 to the BCM (1).

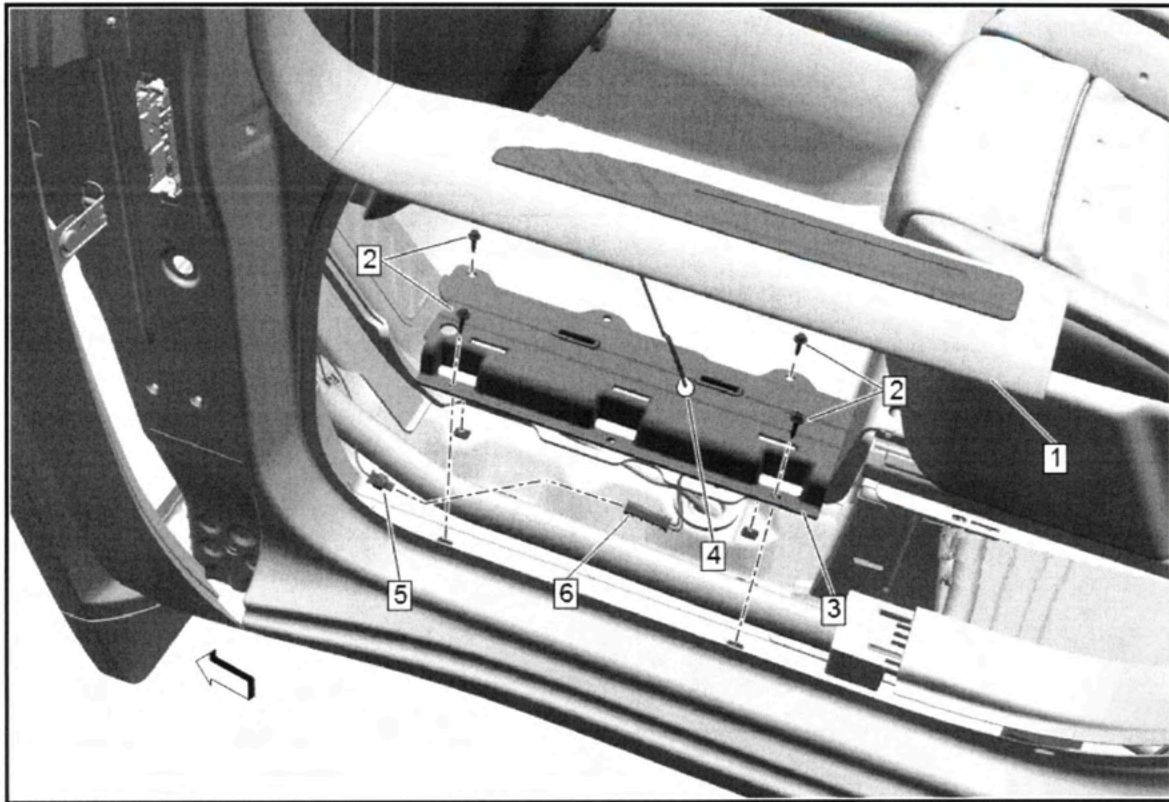

27. Insert the electrical connector (6) of the illuminated sill garnish molding (1) through the previously drilled hole (4) in the harness sill protector (3).
28. Plug in the electrical connector (6) of the illuminated sill garnish molding to the illuminated sill wire harness (5). Do not fully install the harness sill protector and illuminated sill garnish molding at this time.

#### **Check Operation of the Illuminated Sill Plates**

- 28.1. Verify all disconnected electrical connections are re-connected.
  - 28.2. Close all doors
  - 28.3. Open each door, door garnish molding will illuminate with the dome lamp.
  - 28.4. Check to see if the courtesy lights are working.
  - 28.5. Verify that the illuminated sill garnish moldings are operating correctly.
  - 28.6. Pull back the carpet and route the harness along the floor about 50 to 75 mm below the top of the carpet, from side to side.
  - 28.7. Use tie straps, as required, to keep harness secure and from being seen. 8 tie straps are provided in the harness package.
  - 28.8. Secure the sill harness protector (3) to the rocker panel with the previously removed screws (2). Tighten screws to 2.5 N.m (22 lb in).
- Note:** The illuminated sill plates can be installed on either side of the vehicle.
- 28.9. Align the illuminated sill garnish molding snap features to the holes on the sill harness protector and forward vertical wall.
  - 28.10. Firmly press into place until the illuminated sill garnish molding (1) is fully seated.
  - 28.11. Repeat for the second illuminated sill plate on the opposite side of the vehicle.

#### **Re-install Carpet and Trim**

© 2022 General Motors. All rights reserved.

2. Tuck wire harness behind carpet and trim.
3. Reposition carpet, and reinstall removed trim panels.

**Note:** Verify all wires are neatly secured, not pinched and not visible, tie straps should be used as necessary to keep harness secured and out of sight.

### **Functional Verification**

The sill plates will illuminate when doors are open, it will light up at the same time as the dome lamp.