



INSTALLATION INSTRUCTIONS

Trans4mer Grille Guard/Winch Mount For 2007 Chevrolet Silverado 1500 Kit 75230 (Black) and 76007 (Stainless)

Your safety, and the safety of others, is very important. To help you make informed decisions about safety, we have provided installation and operating instructions and other information on labels and in this guide. This information alerts you to potential hazards that could hurt you or others. It is not possible to warn you about all potential hazards associated with this product, you must use your own good judgment.

**CARELESS INSTALLATION AND OPERATION CAN RESULT IN SERIOUS INJURY OR EQUIPMENT DAMAGE.
READ AND UNDERSTAND ALL SAFETY PRECAUTIONS AND OPERATING INSTRUCTIONS BEFORE
INSTALLING AND OPERATING THIS PRODUCT.**

This guide identifies potential hazards and has important safety messages that help you and others avoid personal injury or death. **WARNING** and **CAUTION** are signal words that identify the level of hazard. These signal words mean:

WARNING signals a hazard that could cause serious injury or death, if you do not follow recommendations.

CAUTION signals a hazard that may cause minor to moderate injury, if you do not follow recommendations.

This guide uses **NOTICE** to call attention to important mechanical information, and **Note**: to emphasize general information worthy of special attention.

WARNING

INJURY HAZARD

Failure to observe these instructions could lead to severe injury or death.

- Always** use extreme caution when drilling on any vehicle. Make sure that all fuel lines, brake lines, electrical wires, and other objects are not punctured or damaged when/if drilling on the vehicle. Thoroughly inspect the area to be drilled (on both sides of material) prior to drilling, and relocate any objects that may be damaged. Failure to inspect the area to be drilled may result in vehicle damage, electrical shock, fire or personal injury.
- Always** wear safety glasses when installing this kit. A drilling operation will cause flying material chips. Flying chips can cause eye injury.
- Always** use extreme caution when cutting and trimming during fitting.
- Always** remove jewelry and wear eye protection.
- Never** lean over battery while making connections.
- Always** insure components will remain secure during installation and operation.
- Always** tighten all nuts and bolts securely, per the installation instructions.
- Always** replace all worn or damaged parts before operating.
- Never** operate this WARN product with damaged or missing parts.

Caution

Moving Parts Entanglement Hazard

Failure to observe these instructions could lead to minor or moderate injury.

- Always** take time to fully read and understand the installation Instructions included with this product.

Read installation instructions thoroughly.

Notice

Equipment Damage

- Always** refer to the Operator's Manual, supplied in the winch kit, for all wiring schematics and specific details on how to wire a WARN winch product to your vehicle.

Read Operating Manual thoroughly.

This WARN Trans4mer system can be customized to give your vehicle a wide variety of looks, front-end protection and winch mounting capability. The system starts with this strong two-tube grille guard that attaches to the truck's frame with brackets designed to handle up to a 12000 lb mid frame winch. It is durable and good looking as a stand-alone grille guard, but can be easily upgraded with some great options! You can add a third large size tube (light bar) that adds even more protection and includes tabs for mounting auxiliary lights. The tubes can be mounted in a variety of positions to achieve the look and function that you desire. You can mount a winch carrier bracket that provides a permanent mount for a Warn winch. You may also add a receiver bracket that will handle the Warn multi-mount winch system. Finally, brush guards that protect the headlights and front corners of the vehicle can be easily added to any of the options above.

Before You Begin

- Read and understand these Installation Instructions.
- Refer to Figure A to become familiar with the components and hardware in this kit.

PARTS LIST

<u>PART NO.</u>	<u>QUANTITY</u>	<u>DESCRIPTION</u>
75229/76008	2	Side Member, Black/Stainless
29366/60326	2	2.5" Grille Guard Tube, Black/Stainless
29147	4	Washer, Plastic (Black Kit only)
75232	1	Frame Extension, RH
75231	1	Frame Extension, LH
75234	1	Frame Bracket, RH
75233	1	Frame Bracket, LH
75333	2	Frame Ext. Spacer
74208	2	Spacer
13222	2	Tow Hook, Black
13230	2	Tow Hook, Stainless

TORQUE SPECIFICATIONS

BOLT SIZE	TORQUE
3/8 inch	30 lb. ft (40.7 N-m)
7/16 inch	50 lb. ft. (67.8 N-m)
1/2 & 5/8 inch	75 lb. ft. (101.7 N-m)

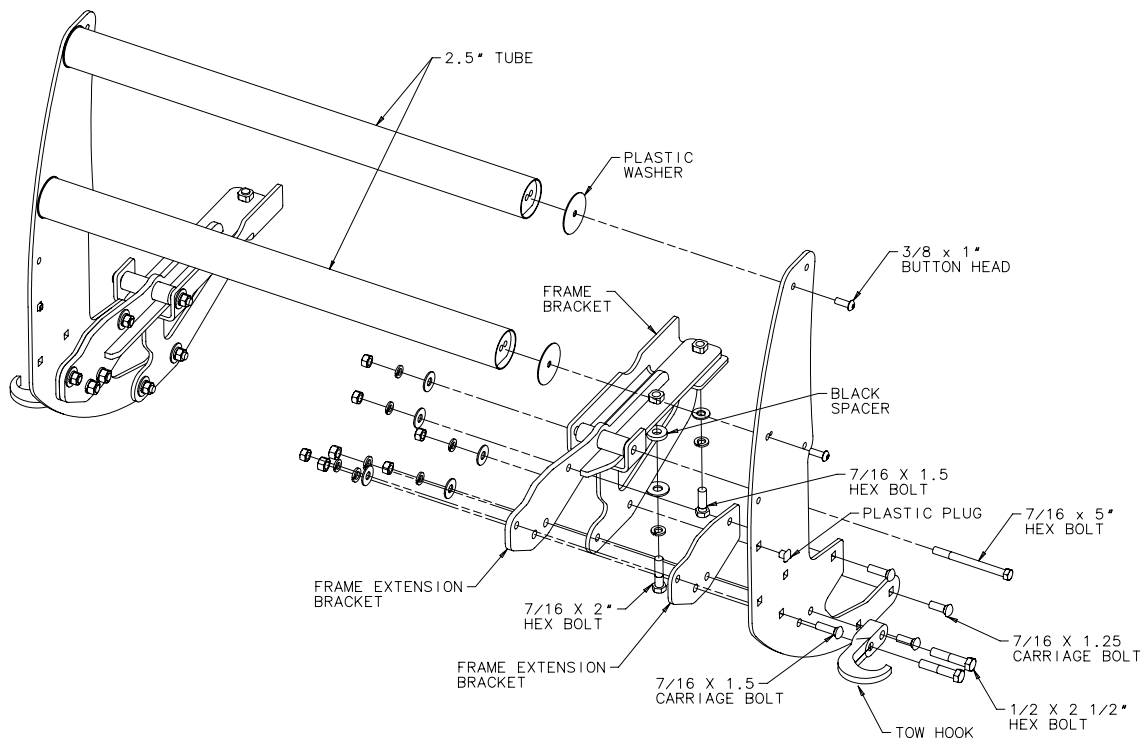

Figure A. Exploded View

NOTE: This installation requires hole drilling. Make sure you have a drill motor and a sharp 1/2" drill bit available. Wear safety goggles.

NOTE: Follow the instructions step by step for fastest installation. Do not securely tighten fasteners until directed to do so.

NOTE: Installation of the included power interrupt kit and long black winch ground cable is required for this installation due to the battery being placed at the rear of the engine compartment.

(A) Remove the air dam by removing the bolt in each end and carefully prying the clips apart. Start on one end and work across to the other end of the air dam.

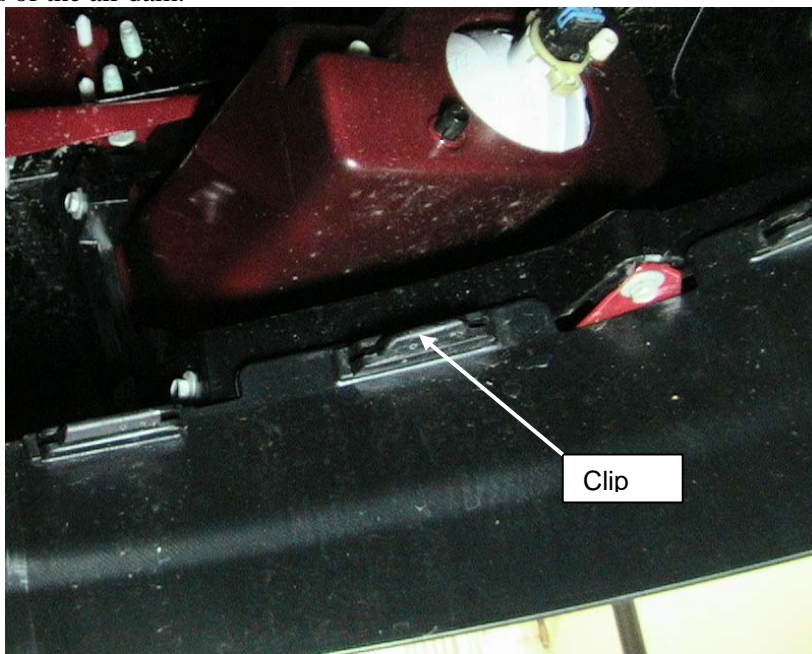

Figure B

(B) Remove the tow loops by removing the two bolts that fasten them to the vehicle. One is a short bolt at the rear of the tow loop assembly the other is a long bolt that passes through the entire frame and fastens with a nut. (discard both bolts)

(C) Trim the tow loop bezel plastic as shown in Figure C.

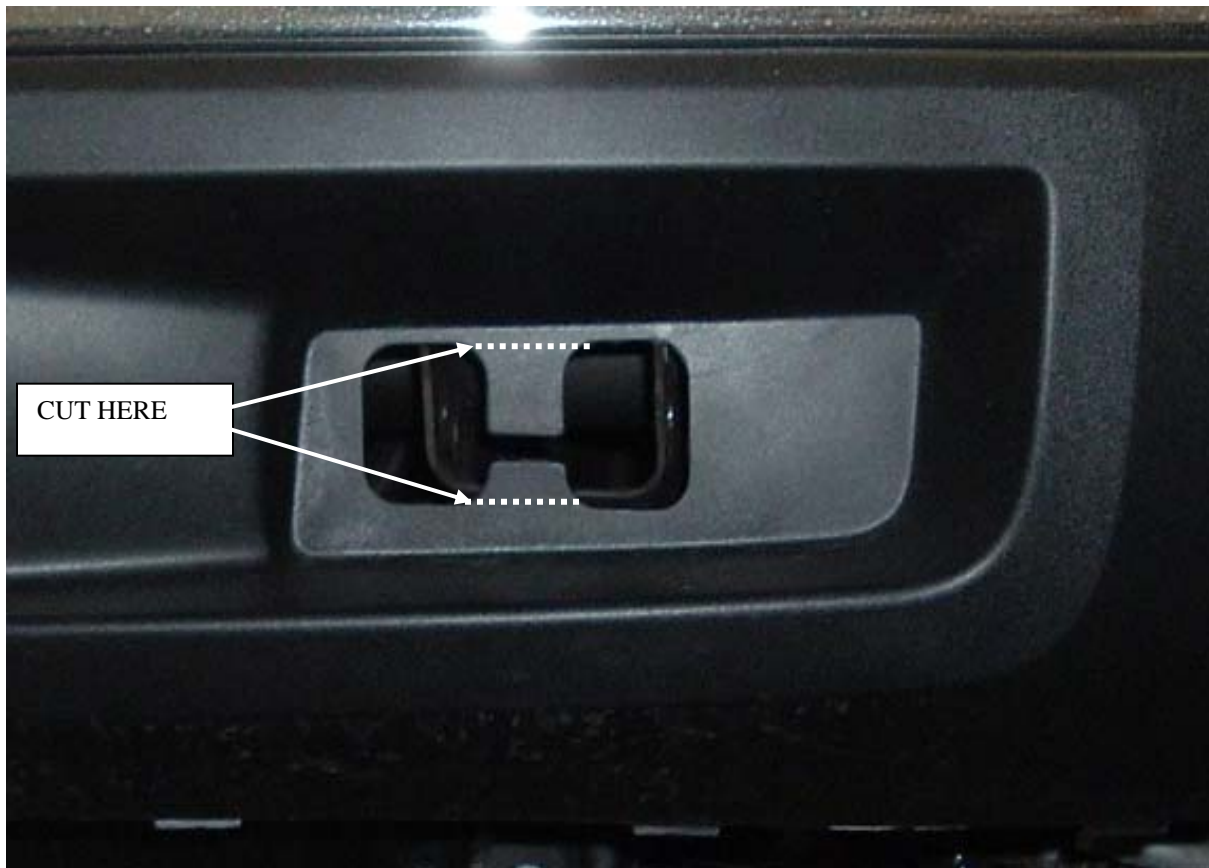

Figure C.

- D) Remove the plastic retaining pins from the radiator cover (shown in Figure D) by using a flat blade screw driver and gently prying up the center pin. Pull center pin up until it stops then use the flat blade screw driver to gently pry the entire retaining pin out of the recessed hole. Keep these pins for use when putting the cover back on after installation is complete. Not all pins are shown in Figure D.



Figure D.

1. Install the frame bracket temporarily on the passenger side frame using the 7/16" x 5" bolt and 7/16" lock washer and nut provided in kit. The bracket uses the same hole as the long bolt from the tow loop. Repeat for driver side frame. (See figure 1.)

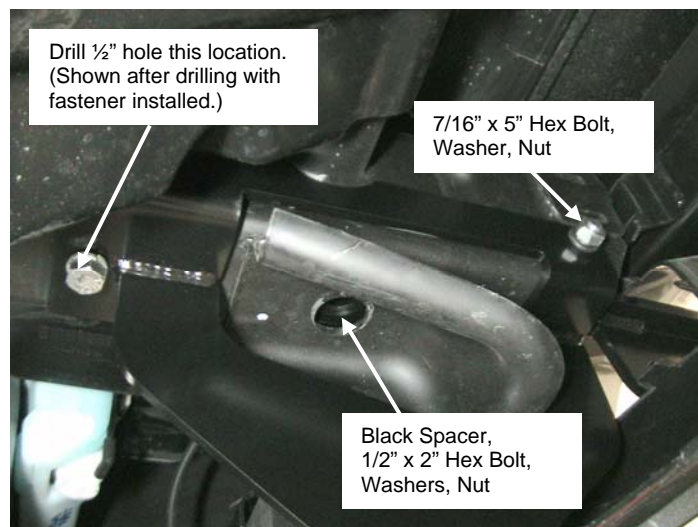

Figure 1 Placement of the Frame Bracket (Driver Side)

2. Mark the rear hole location on each frame and center punch each hole if possible. Make sure the bracket is tight against the frame before marking the location.
3. Remove frame brackets from frame.

4. Drill a 1/2" hole through the bottom of each frame. Wear safety goggles and use caution when drilling the holes. See figure 2.

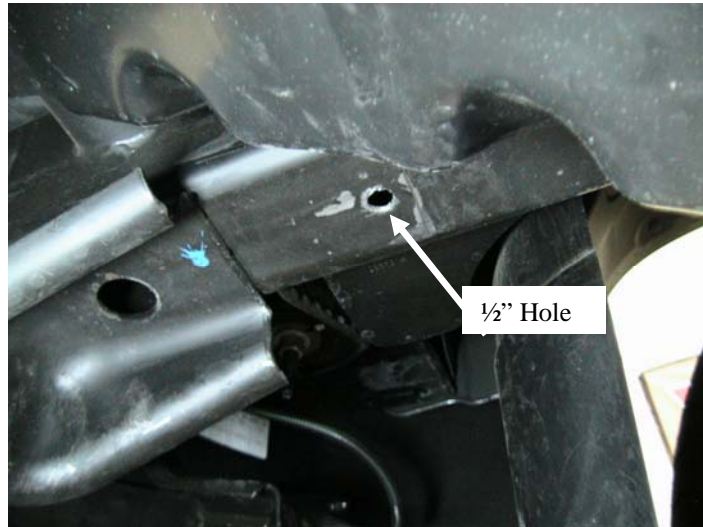

Figure 2 Drilled Hole

5. Remove the bumper attachment bolt that is installed through the top of the frame. See figure 3.

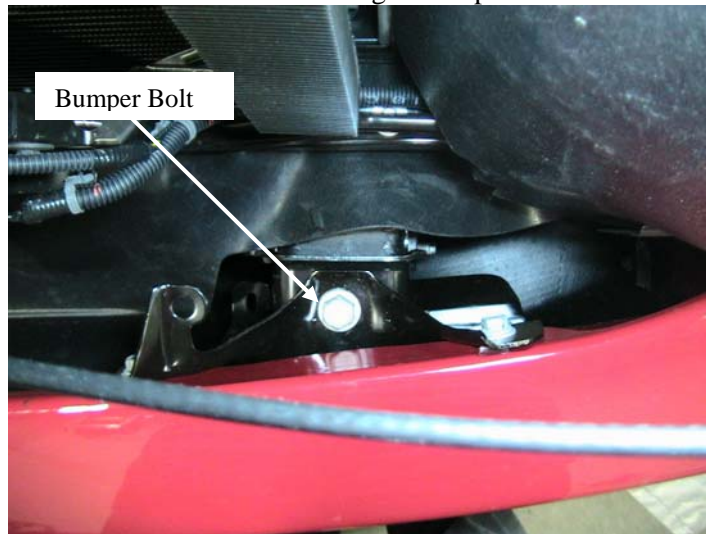

Figure 3. Vertical Bolt (Grill removed for clarity)

6. Install the frame extension brackets through the tow loop holes in the bumper and slide them into the vehicle frame as shown in figure 4. Make sure the correct bracket is used for each side. The brackets are very similar.

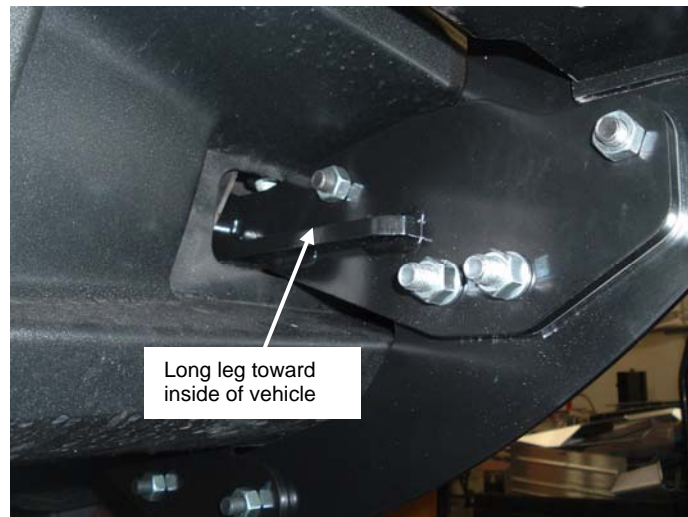

Figure 4 Frame Extension Installed

7. Re-install vertical bumper bolt with a black spacer as shown in figure 5. (Spacer in figure 5 is shown uncoated.)

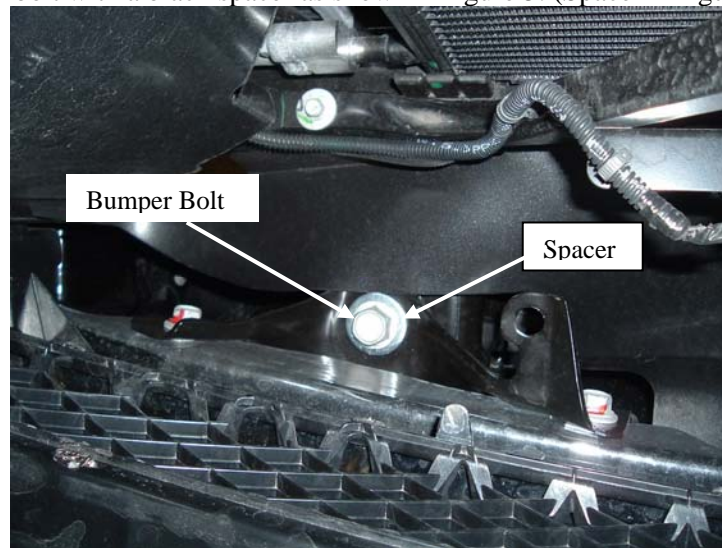

Figure 5. Bumper Bolt and spacer

8. Install the frame bracket as performed in step 1.
9. Install a 1/2" x 1 1/2" bolt in the rear hole of each lower bracket. Use a 1/2" flat washer and 1/2" lock washer with each bolt. See figure 1.
10. Install a 1/2" x 2" bolt in the middle hole of the frame bracket. Use the round black spacer, an oversized flat washer, and lock washer. **NOTE: The spacer must be placed in the large hole in the bottom of the frame so it rests against the frame extension inside the frame. The oversized washer will hold it in place once the bolt and lock washer are installed.** See figure 2.
11. Cut 3/4" slots in air dam. Measure 15 5/8" from center of air dam and mark the location. Measure 3/4" outward from that mark and mark that location. Measure 1" up from the bottom of air dam between the two marks. Mark lines on the air dam at the positions marked. This will be the slot location. Repeat in other direction.
12. Check the position of the slots by holding the air dam in position centered on the vehicle. If slots markings do not line up with lower brackets protruding forward, recheck measurements and correct as needed.
13. Once satisfied position is correct, cut the slots out using a razorblade knife, coping saw, or another suitable tool. Use caution when cutting to avoid injury or ruining the air dam. **Wear Safety goggles when cutting or drilling.**
14. Reinstall the air dam.

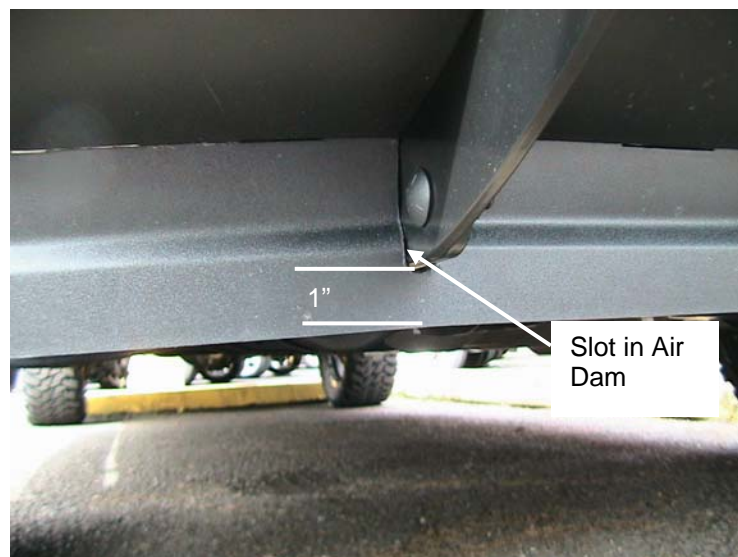

Figure 6. Side Member Through Slot.

15. Install side members. Place frame extension spacer between frame extension and side member. Insert two 7/16" x 1 1/2" carriage bolts through the side member, spacer, and frame extension. Install a flat washer, lock washer, and hex nut on each carriage bolt. **NOTE: Stainless steel kits use only socket head bolts and self locking nuts.**



Figure 7. Mounting Side Member.

16. Insert two 7/16" x 1 1/4" carriage bolts through the bottom leg of the side member and lower frame bracket. Install a flat washer, lock washer, and hex nut on each carriage bolt. **NOTE: Stainless steel kits use only socket head bolts and self locking nuts.**
17. Install the 2.5" diameter tube in one of the middle front holes in the side members. Ensure there is enough room between the winch and the tube to allow easy access and operation of the winch. Check clearance for connecting the remote control. Special plastic spacers are provided for use on the black kit. The spacers must be placed between the tube and the side member. Insert a 3/8" x 1" socket head cap screw through side member, spacer, and into center hole of tube.
18. Install the 2.5" diameter tube in the top front hole between the side members. Special nylon spacers are provided for use on the black kit. The spacers must be placed between the tube and the side member. Insert a 3/8" x 1" socket head cap screw through side member, spacer, and into center hole of tube.
19. If brush guards are being installed, install them before proceeding to next step. Installation instructions are provided with the brush guard kit.

20. If installing a winch carrier, install it now according to the instructions provided in the carrier kit. **NOTE:** **Installation of the included power interrupt kit and long black winch ground cable is required for this installation due to the battery being placed at the rear of the engine compartment.** Follow the instructions included in the power interrupt kit when installing it. Replacement of the winch ground cable requires removing the current ground cable from the bottom of the motor and replacing it with the longer one included in this kit.
21. Install the tow hooks as shown in figure 6, using two 1/2" x 2 1/2" hex bolts, flat washers, lock washers, and hex nuts for each tow hook.

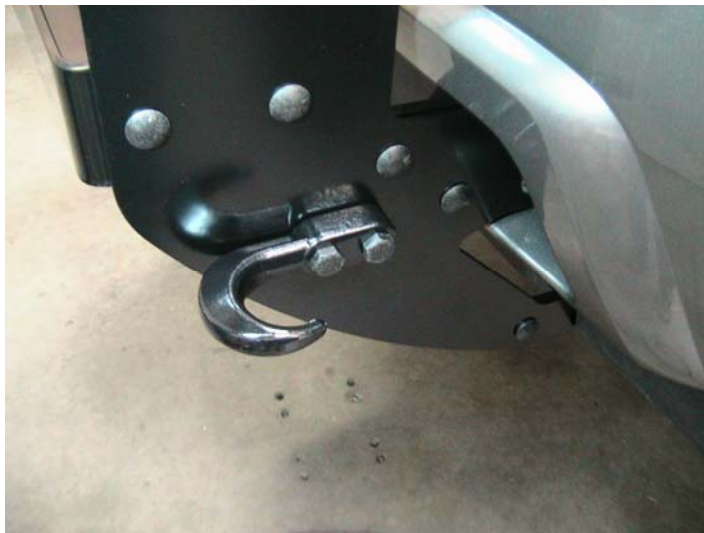

Figure 8 Installing Tow Hooks

22. Tighten all fasteners previously installed starting with the winch carrier working down and back to the frame bracket.
23. Next tighten tube and brush guard bolts.
24. Tighten frame extension and lower bracket fasteners.
25. Verify all fasteners are tightened to torque specification from page 1.
26. Install the radiator cover panel removed in step (D).

⚠ WARNING

READ THE VEHICLE'S OPERATOR MANUAL, WINCH OPERATOR MANUAL, AND ALL WARNING LABELS PRIOR TO OPERATION OF WINCH.

⚠ WARNING

FAILURE TO SECURELY TIGHTEN ALL BOLTS ON THE WINCH PLATE, WINCH, AND FAIRLEAD CAN RESULT IN PRODUCT FAILURE WHICH MAY RESULT IN VEHICLE DAMAGE AND OPERATOR INJURY OR DEATH. DOUBLE CHECK THAT ALL BOLTS ARE SECURELY TIGHTENED PRIOR TO USE.

Warn Industries Stainless Steel Truck Accessories

What to expect:

Polished stainless steel combines the beauty of a chrome-like appearance with extreme durability and corrosion resistance. With a minimum amount of care, the appearance will last almost indefinitely. Unlike plating or coatings, there is nothing to peel off or wear away that would allow corrosion underneath.

The actual appearance may not be exactly like new chrome in either the degree of luster or color. There may be fine polishing lines visible up close and small differences between mating parts of an assembly. A grille guard, for instance, may have small differences between the round tubing and the flat plate. The backside of a part may not be as highly polished as the front. However, part of the beauty and appeal of stainless actually lies in the smooth “hand-worked” appearance.

There also is a possibility that small rust spots can appear on stainless products. They are usually due to minor iron contamination on the surface as a result of normal manufacturing and handling processes. This minor rust, if it occurs at all, is easy to remove and will not tend to spread.

Recommended care:

Regular washing with fresh water and mild car wash detergents followed by rinsing and drying with a soft towel is the best minimum care. Beyond that, any cleaner/wax recommended for automotive finishes will work well to remove minor stains and scuffs, enhance the shine and provide protection. Always use clean soft cotton cloths. In most cases, this will be all that is required for many years. For more serious blemishes or a rust spot, use a cream metal polish recommended for stainless, aluminum, etc. Try to rub in the direction of the original polishing lines.

Ultimately, any stainless part can be restored to a brilliant shine with power buffing processes.

Caution:

Do not use steel wool or any type of metal scraper. Do not use “Scotch Brite” pads or abrasive powdered cleaners. Do not try to clean with muriatic acid or any other acid.

Stainless Fasteners

Stainless steel fasteners are included in many of the stainless kits. These fasteners provide similar corrosion resistance and appearance as the rest of the kit. However, stainless fasteners are prone to galling when installed in similar stainless material. It is a good idea to apply a small amount of anti-seize compound to the threads when installing them. Care should also be taken when tightening the fasteners to prevent rounding or deforming the corners of the bolts. Make sure the wrenches are the correct size and fit properly. In the case of socket heads, the wrench should have sharp, un-worn edges. With a few precautions during assembly the products should provide years of service.

WARNING

PERFORM REGULAR INSPECTIONS ON THE WINCH, WINCH MOUNT, AND RELATED HARDWARE. NEVER OPERATE THE WINCH OR WINCH MOUNT WITH DAMAGED OR MISSING PARTS. FAILURE TO FOLLOW THIS WARNING MAY CAUSE VEHICLE DAMAGE AND OPERATOR INJURY OR DEATH.